

Design Options



MODELS



DESIGN OPTIONS

www.waterlodge.com
info@waterlodge.com

WATERLODGE
PREMIUM HOUSEBOATS



TABLE OF CONTENTS:

<u>1. LIGHTING</u>	<u>4</u>	<u>21. SWITCHES, SOCKETS, SOLAR SYSTEM</u>	<u>29</u>
1.1 INTERIOR LIGHTING	4	<u>22. HEATING AND BOILER</u>	<u>30</u>
1.2 OUTDOOR LIGHTING	4	22.1 HEATING FURNACE	30
1.3 OUTDOOR LIGHTING ON TERRACES	5	22.2 BOILERS	31
<u>2. INSIDE DOOR</u>	<u>5</u>	<u>23. DECORATIVE RADIATOR</u>	<u>32</u>
<u>3. DULUX PAINT</u>	<u>6</u>	<u>24. BATHROOM LADDER HEATER</u>	<u>33</u>
<u>4. EXTERNAL CLADDING</u>	<u>7</u>	<u>25. GAS BOX AND GAS SWITCH</u>	<u>33</u>
4.2 VINYLIT FACADE	7	<u>ADDITIONAL EQUIPMENTS</u>	<u>35</u>
4.1 VOX	7	<u>26. FLOATING PACKAGE</u>	<u>36</u>
<u>5. FLOOR</u>	<u>8</u>	26.1 NAVIGATION LIGHT AND ROPES	36
5.1 KRONOSPAN ROCKO	8	26.2 SONARS	36
5.2 IVC LAYRED 55	8	26.3 ENGINES	37
<u>6. SKIRTING BOARD</u>	<u>9</u>	26.4 STEERING CONSOLE AND WHEEL	38
<u>7. CEILING</u>	<u>9</u>	26.5 ANCHOR, BEAMS AND FLOATS	39
<u>8. BATHROOM WALL COVERING</u>	<u>10</u>	<u>27. MODIFIED WINDOWS AND DOORS</u>	<u>40</u>
<u>9. BATHROOM CABINET AND SINK</u>	<u>12</u>	28.1 SPIRAL	41
<u>10. SHOWER ENCLOSURE</u>	<u>13</u>	<u>28. STAIRCASE</u>	<u>41</u>
<u>11. TOILET</u>	<u>13</u>	28.3 LADDER	41
<u>12. IKEA KITCHEN</u>	<u>14</u>	28.4 FRONT STRAIGHT	41
12.1 KITCHEN FRONTS	14	28.2 STRAIGHT	41
12.2 WORKTOP	16	<u>29. SIDE RAILINGS AND FLEXI TEAK</u>	<u>42</u>
12.2.1 KITCHEN WALL	17	<u>30. WATER-WASTE SYSTEMS</u>	<u>43</u>
12.3 SINK	18	<u>31. BEDROOM</u>	<u>44</u>
12.4 KITCHEN TAPS	20	31.1 WARDROBE AND BED	44
12.5 HANDLES	22	<u>32. TV, RADIO AND SOCKET</u>	<u>45</u>
<u>13. KITCHEN STOVE AND FRIDGE</u>	<u>24</u>	<u>33. SAUNA AND GRADUATION TOWER</u>	<u>46</u>
<u>14. MICROWAVE AND DISHWASHER</u>	<u>25</u>	<u>34. CURTAINS</u>	<u>46</u>
<u>15. OVEN</u>	<u>25</u>	<u>35. BLINDS</u>	<u>47</u>
<u>16. BAR</u>	<u>26</u>	36.1 EXTERNAL COLORS	48
16.1 BAR TABLE	26	<u>36. MODERN</u>	<u>48</u>
16.2 BAR LAMP	26	36.2 KITCHEN, BATHROOM TAPS	49
<u>17. OUTSIDE WINDOWS AND DOORS</u>	<u>27</u>	AND SHOWERS	49
<u>18. RAILINGS</u>	<u>28</u>	36.3 BATHROOM CABINETS	50
MADE OF STAINLESS STEEL	28	36.4 FABRIC WALLS	50
<u>19. TERRACE BOARD AND CLEAT</u>	<u>28</u>	36.5 KITCHEN LAYOUT	51
<u>20. WATER POMPS</u>	<u>29</u>	<u>37. LAYOUTS</u>	<u>52</u>

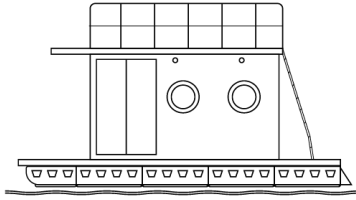

WATERLODGE
PREMIUM HOUSEBOATS

Floating Vacation Homes

DESIGN OPTIONS



MODELS

WATERLODGE
PREMIUM HOUSEBOATS

1. LIGHTING

1.1 INTERIOR LIGHTING



LED STRIPS

1.2 OUTDOOR LIGHTING



LED STRIPS

1.3 OUTDOOR LIGHTING ON TERRACES



LED SPOTLIGHTS

2. INSIDE DOOR



VECTOR Premium
MODEL E



VECTOR Premium MODEL
E with porthole



Sliding Door vector
Options



Magix inox

We know that for every human being is the most important house, and each house begins with a door. They open and close intimate world in which we want to feel happy and safe. Our passion is to create such a door that will be open with the desire and joy, to overstep the threshold in the most important place for you in the world - your home.

3. DULUX PAINT



SCANDINAVIAN GREY

You can choose any color from the Dulux pallet

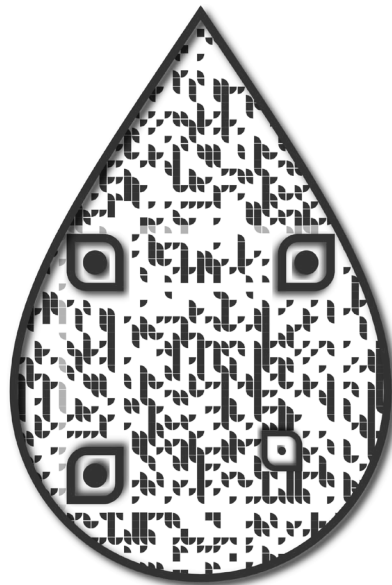

The Dulux Visualizer App

An overview of paints that will help you deliver the perfect results for any project

4. External Cladding

4.1 VOX



Modern Wood,
White



Modern Wood,
Claystone

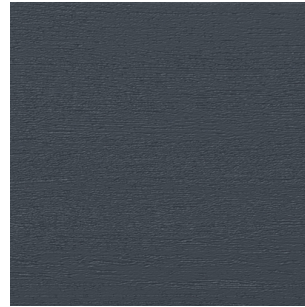

Modern Wood,
Anthracite



Modern
Wood, Ivory



Modern Wood,
Pearl Grey

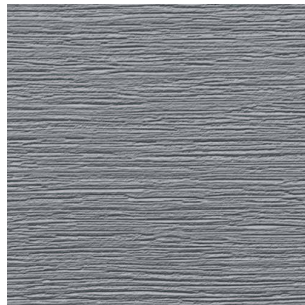

Modern Wood,
Quartz Grey



Concrete Oak



Malt Oak

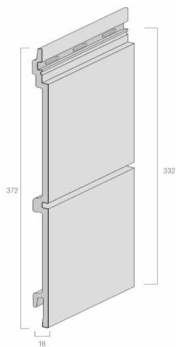

Double board

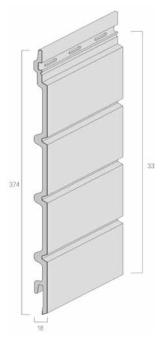

Fourfold board

VOX Cladding Board Types

4.2 VINYLIT FACADE

OPTIONS



Sheffield Concrete
Oak with Shadow



Turner Malt Oak
with Shadow

5. FLOOR

5.1 KRONOSPAN ROCKO



CRYSTAL
SHORE



BOURBON
CASK



BARISTA



CASTLEBRIDGE



CRESCENDO



SCANDIPURE



The KRONOSPAN brand focuses its attention on the person, its needs and values, which is why we create our products and services, utilizing the knowledge from various humanistic disciplines. Thanks to the cooperation with psychologists, sociologists or anthropologists, we are able to design solutions, which support our customers in developing interiors, which provide freedom and enable fulfilling life passions.

5.2 IVC LAYRED 55

UPGRADE OPTIONS



COUNTRY OAK
54945



COUNTRY OAK
24277



COUNTRY OAK
24842

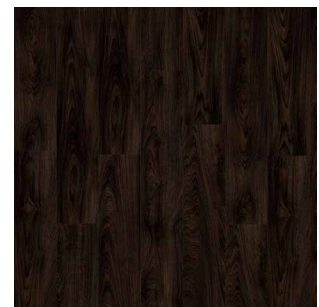

LAUREL OAK 51992

LayRed is the engineered vinyl floor collection from Moduleo: a rigid flooring solution with a strong core, yet with a soft feel and silent acoustics. A premium quality floor with integrated underlay – the signature red back of Moduleo LayRed – engineered to stand its ground in any room and designed to be beautiful everywhere.



6. SKIRTING BOARD



GRAY



BROWN

7. CEILING



MATT

8. BATHROOM WALL COVERING



Natural Teak



Vogue Wood

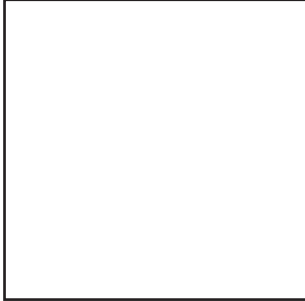

White



Dolce Vita



Almond
Oak



Breccia
Paradiso



Travertine
Silver



Calacatta
Marble



Slate
Sequoia



Antique
Mascarello



Blue
Storm



Jet
Sequoia



Black
Walnut



Oiled
Olivewood



Couture
Wood

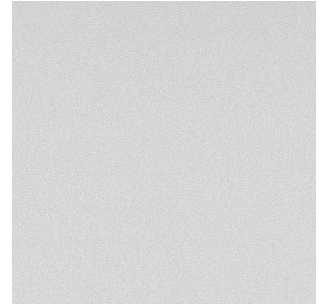

Frosted
Dusk

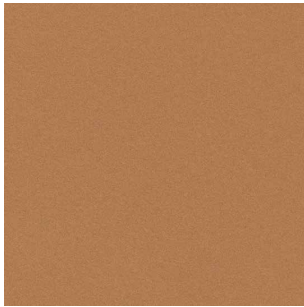

Frosted
Copper

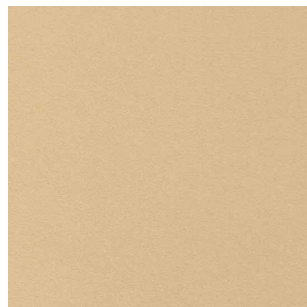

Frosted
Gold

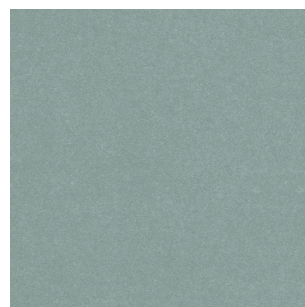

Frosted Jade



Classic
Weng



PREMIUM GLOSS FINISH *by* FORMICA GROUP

AR+ is a High Gloss HPL with a superior scuff and mar resistance and therefore usable on vertical and horizontal surfaces. Formica's own laboratory tests show remarkable results. It has also been tested externally by LGA Institute with official certification of AR+ superior performance.

Steel wool? Yes, one has to push really hard to get even the smallest scuff on AR+. It is also available in other designs and trendy colors.

AR+ not only performs better in scuff and mar resistance than any gloss HPL product in the market, but it also keeps the gloss level after heavy use. AR+ is a durable high gloss that will make the furniture look newer for longer.

9. BATHROOM CABINET AND SINK



SET MODUO SLIM
40x22 GREY



SET MODUO SLIM
40x22 WHITE



SET MODUO SLIM
50x38 GREY



SET MODUO SLIM
50x38 WHITE



SET MODUO SLIM
60x38 GREY



SET MODUO SLIM
60x38 WHITE



SET MODUO SLIM
80x38 GREY



SET MODUO SLIM
80x38 WHITE

The range includes top-quality cabinets and cubicles in a variety of colours and sizes. The smart functionalities included optimise the storage space and convenience of organising your bathing utensils and beauty appliances. All bathroom furniture pieces are preserved with a quality coating system to improve the ease of cleaning. Create a beautiful and convenient bath space.

10. SHOWER ENCLOSURE



Sliding Door Shower enclosure DTr/BASIC



Square or rectangular corner shower enclosure KN/TX5b

11. TOILET



TOILET 24V/230V

STANDARD



WALL HUNG TOILET

UPGRADE
OPTIONS



CINDERELLA STANDARD

UPGRADE
OPTIONS



CINDERELLA COMFORT

UPGRADE
OPTIONS

12. IKEA KITCHEN

12.1 KITCHEN FRONTS



**VOXTORP WHITE WITH
OUT HANDLES**



KUNGSBACKA



**VOXTORP GREY WITH
OUT HANDLES**

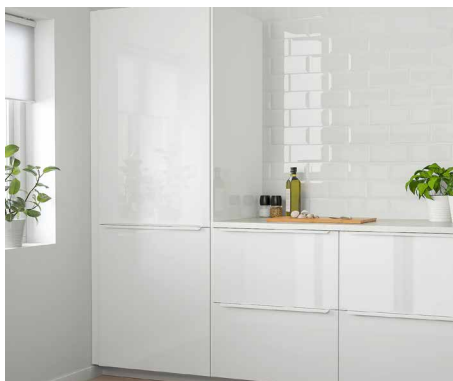

RINGHULT LIGHT WHITE



ASKERSUND JESION

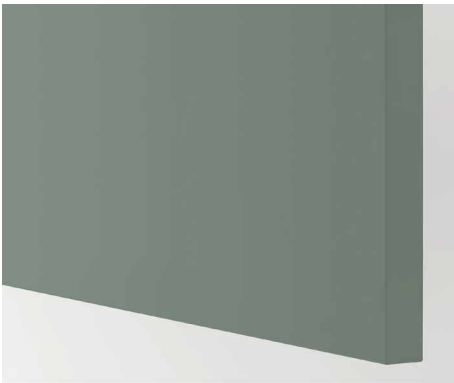

BODARP



ENKÖPING

With the ikea system you have endless of possibilities when designing your kitchen. Whether you have a taste for the traditional, love the minimalism in modern style or land somewhere in between, you'll surely find something that fits you.

12.2 WORKTOP

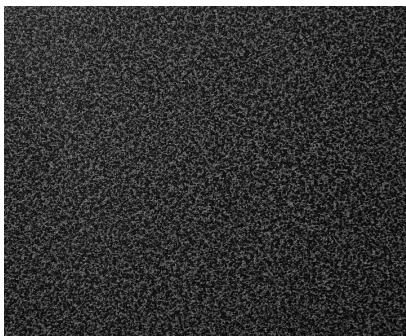

EKBACKEN BLACK STONE

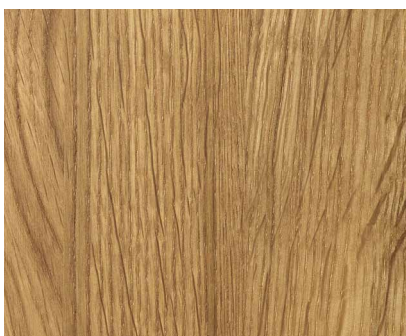

KARLBY OAK



EKBACKEN LIGHT GREY

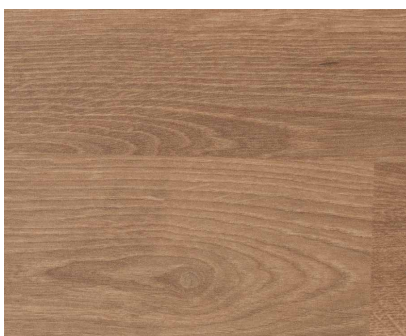

SÄLJAN OAK



EKBACKEN BETON

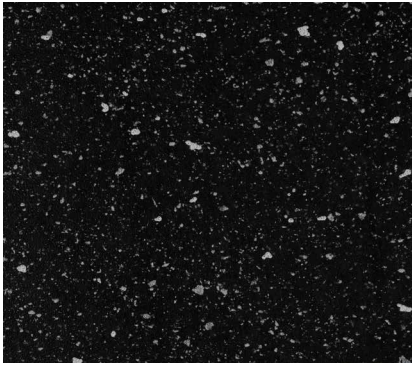

SÄLJAN BLACK MINERAL

12.2.1 KITCHEN WALL



WHITE WALL PLATE



STAINLESS STEEL PLATE



SCANDINAVIAN GREY
WALLPAPER

Our ready-made and custom-made kitchen worktops are tested against everyday kitchen challenges like liquids, oil, food and scratches – so you know they will last.

12.3 SINK



BOHOLMEN 47X30



FYNDIG 46X40



LANGUDDEN 46x46

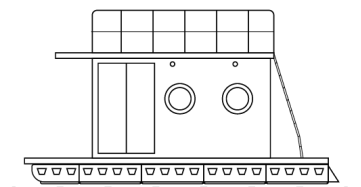

UPGRADE OPTIONS



CHICHI-LAVEO



ZORBA: ZQZ 2513



ZORBA: ZQZ G11A

Find sinks and taps to add the finishing touches to your kitchen here. Our kitchen sinks and taps are all as good-looking as they are functional, with plenty of different styles to match the look of your kitchen. Whichever tap you choose, you'll save water with every use, thanks to an integrated aerator that mixes in air and reduces your water and energy consumption significantly.

12.4 KITCHEN TAPS



ALPINE: BGA 063M



ÄLMAREN

UPGRADE OPTIONS



ASTER: BCA B730



NEMEZJA: BEN 262M



SILIA: BQS B730

12.5 HANDLES



BAGGANAES BLACK



BAGGANAES SILVER



BAGGANAES GOLD



HACKAS



ORRNAES SILVER



OSTERNAS



OSTERNAS DOWN

Knobs and handles are an important finishing touch to your home. Drawer knobs make your cabinets easy to open, while door handles can really tie your room together. We've got a wide range of colors, shapes and sizes to choose from. Most of our designs come in both a knob and handle version, too!

13. KITCHEN STOVE AND FRIDGE

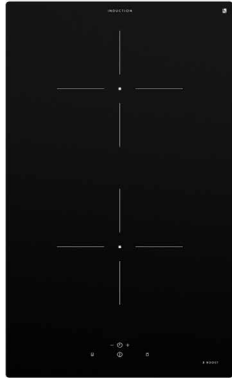

INDUCTION
VÅLBILDAD



NAVY LOAD HOB, 2
BURNERS

GAS



SMALL FRIDGE

UPGRADE OPTIONS

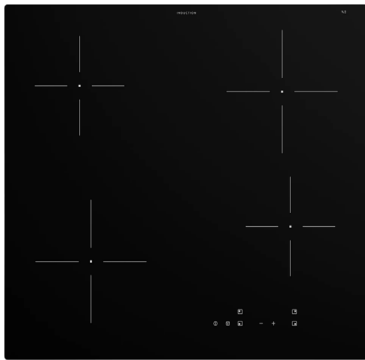

INDUCTION GRUNDAD



NAVY LOAD HOB, 3
BURNERS

GAS



DYNACOOK X2
GAS, NO FLAME

Gas hob, glass ceramic or energy-saving induction? How many burners would you like?

Our range of hobs has something that will match your space and your style of cooking.

Check out our range for a choice that will make your time in the kitchen easier and more fun, every day.

Don't forget to add a kitchen extractor fan, to keep cooking fumes out of the rest of your home.



BIG FRIDGE

14. MICROWAVE AND DISHWASHER



MATTRADITION



MICROWAVE WITH OVEN



DISHWASHER

15. OVEN



MATTRADITION BLACK



MATTRADITION WHITE



SMAKSAK BLACK



SMAKSAK CHROME

Our range of ovens and built-in ovens are designed to suit a variety of cooking styles by offering a wide range of functions and integrated accessories. That means, whether you're a frozen pizza lover, feeding a family, or working your way through cookbooks, you'll find an oven that's right for you. See our range of appliances.

16. BAR

16.1 BAR TABLE



16.2 BAR LAMP



GOLD LAMP



MARKSLÖJD LAMP



BLACK LAMP x3



WHITE LAMP x3

With the flick of a switch, you can change a room's atmosphere with a lamp or light fixture. Want a cozy, calm vibe for movie night? Some pep to start your day? Indoor lighting can set the mood, add style and of course, brighten things up.

17. OUTSIDE WINDOWS & DOORS

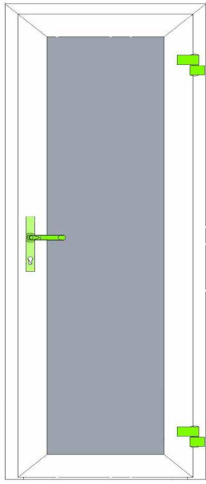

BACK DOOR

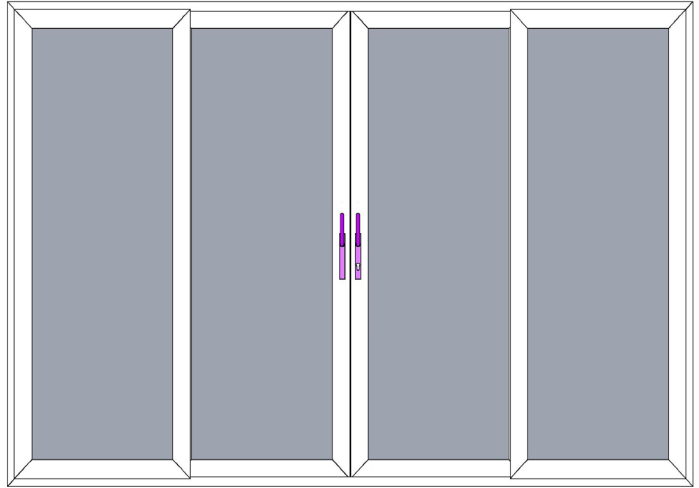

FRONT DOOR

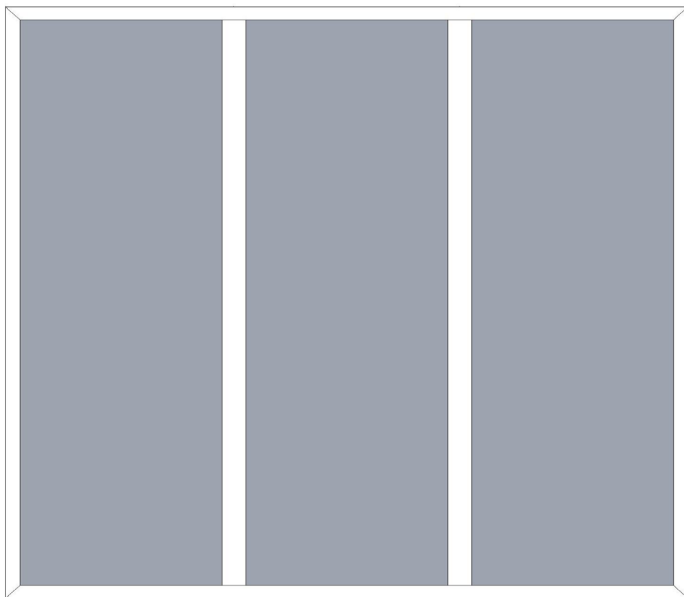

SIDE WINDOWS

FROM APART L TO XXL
2 GLASS FOR XS, S, M



ANTHRACITE

OPTIONS



BLACK



WHITE

18. RAILINGS **MADE OF STAINLESS STEEL**

STEEL 304 or STEEL 316 (non standard)



FRONT AND BACK RAILINGS

19. TERRACE BOARD AND CLEAT



THERMORY THERMO



CLEAT

20. WATER PUMPS



WATER PUMP 230V



WATER PUMP 24V

21. SWITCHES, SOCKETS, SOLAR SYSTEM



BACK SOCKET CONNECTION

FRONT SOCKET CONNECTION



ANTHRACITE

WHITE



NAVIAGATION LAMP 360



CABLE 15M

We have an excellent relationship with all of our suppliers, giving us unrivalled access to the products you need, including a large range of distribution, automation, control and switchgear products.



INVERTER 2.4 KW / 5 KW



SOLAR PANEL 310W



VETUS 220AH



VICTRON ENERGY 220 AH

22. HEATING AND BOILER

22.1 HEATING FURNACE



GAS HEATER – TERMET ECOLINE SLIM



AIR CONDITIONER



WIFI CONTROL



WHITE REGULAR RADIATOR

40/60/80/100/120



RADIATOR 30/50

OPTIONS



UNDERFLOOR HEATING OPTION - HEATING MAT



HYBRID 550W IVORY

22.2 BOILERS



WATER HEATER, ARISTON 50L BOILER



WATER HEATER, ARISTON 50L BOILER, WI-FI (OPTIONS)

23. DECORATIVE RADIATOR



ANTHRACITE



BLACK

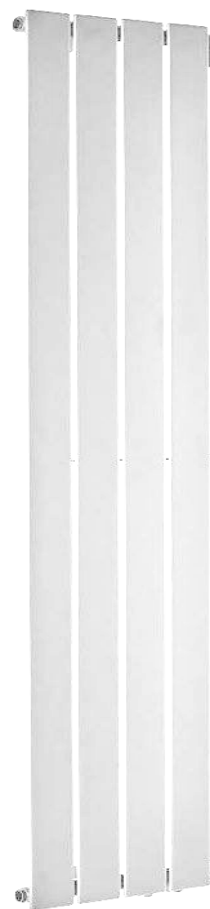

WHITE

24. BATHROOM LADDER HEATER



ELECTRIC



REGULAR
WIDTH 30 OR 50 CM

We want our houseboats to be comfortable, for some people that means control over the settings and temperature, for others uncompromising energy efficiency is most important, and many are looking for quiet performance at a price you can afford. Our goal is to give you that ideal indoor comfort, no matter where you live or what the weather.

25. GAS BOX AND GAS SWITCH



GAS SWITCH



GAS BOX

WATERLODGE

PREMIUM HOUSEBOATS



DESIGN OPTIONS



MODELS

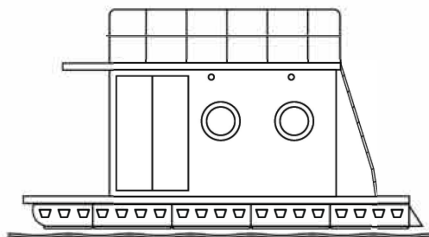

WATERLODGE

PREMIUM HOUSEBOATS

ADDITIONAL OPTIONS

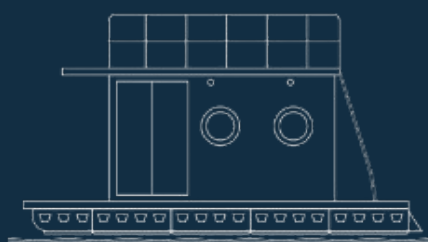

26. FLOATING PACKAGE

26.1 NAVIGATION LIGHT AND ROPES



360 AND SIDE LIGHTS



360 AND BSH LIGHTS



ROPES

26.2 SONARS



SONAR ELEMENT 7,
GPS, HV-100



SONAR I40 DEPTH

26.3 ENGINES



YAMAHA 9.9 HP



HONDA 20 HP



MERCURY 15 HP



YAMAHA 25 HP



E-TECH



TRUSTER



FUEL SEPARATOR



FUEL TANK 100 OR 70 L.

Marine engines: a key technology in continuous innovation
Since the first steamship was invented, sea engines provide motion, reliability and safety to both people and goods. It is an extremely important technological system for the boating world, which over the years has been working to significantly extend the quality of its equipment, in terms of performance and life span.

26.4 STEERING CONSOLE AND WHEEL



BLACK



WHITE

STEERING CONSOLE EXAMPLE



CHOICE WHITE/GRAY



CONSOLE COVER

Steering console for houseboats with a lot of adjustment features. The easy use of the steering console adds to boating pleasure.

26.5 ANCHOR, BEAMS AND FLOATS



EXTRA FRAME AROUND ENGINE

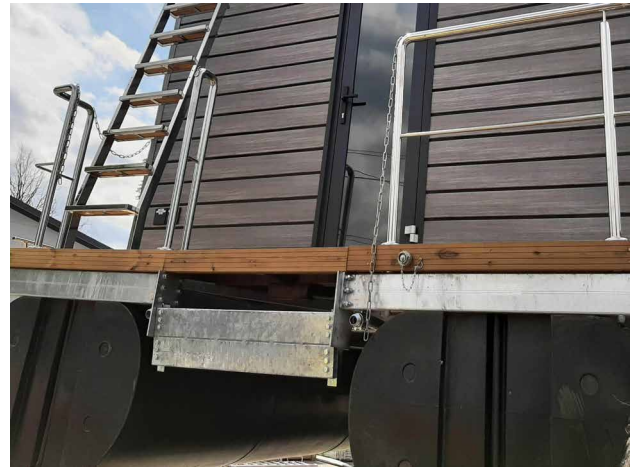

ENGINE CONSTRUCTION WITH OPEN TERRACE

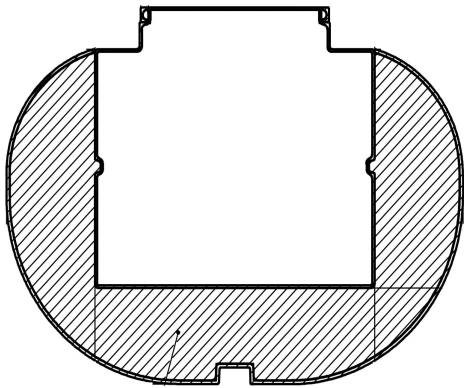

BOX IN FLOAT 470L



TRIMARAN



ANCHOR AND CHAIN



ELECTRIC



MANUAL

27. MODIFIED WINDOWS & DOORS

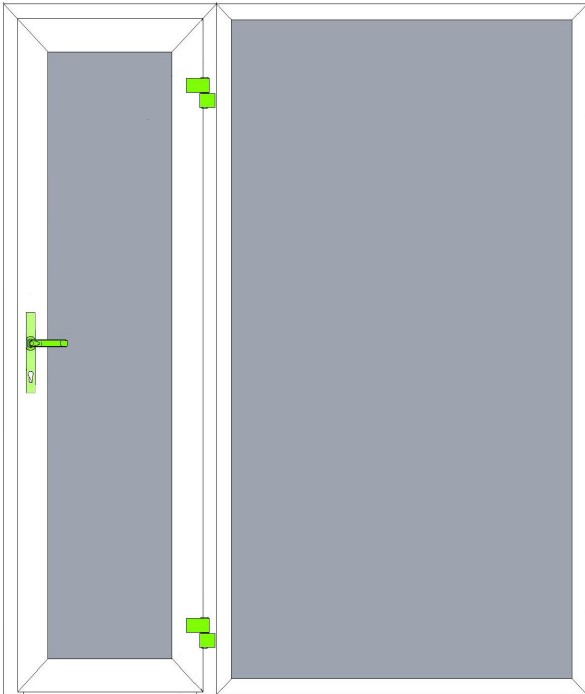

BACK DOOR

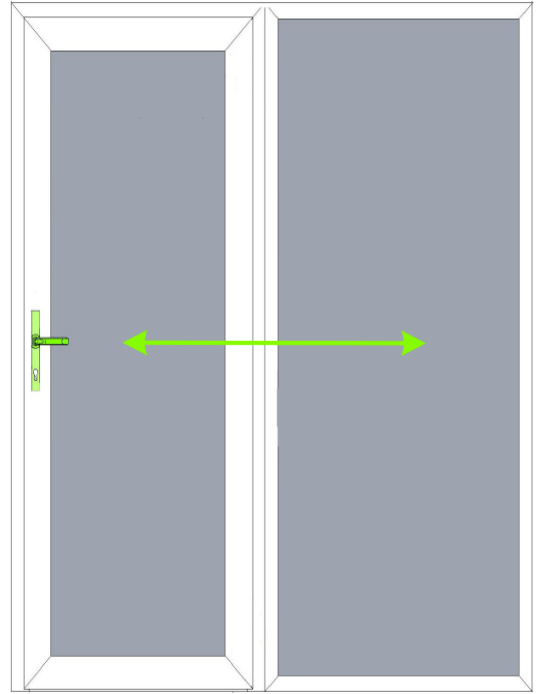

BACK SLIDE DOOR

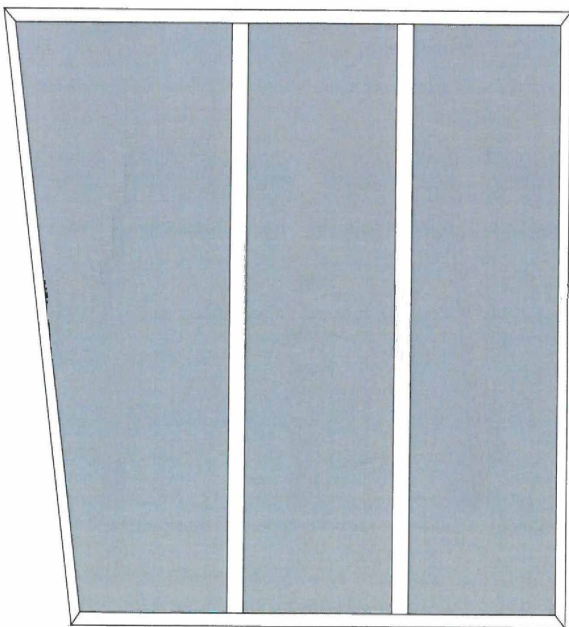

SIDE WINDOWS

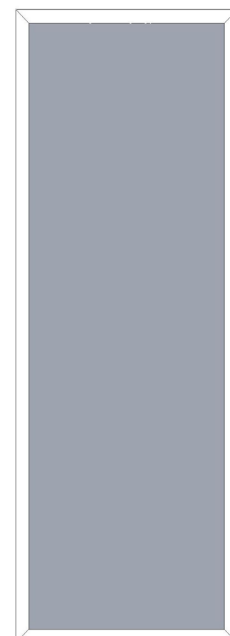

SINGLE SIDE WINDOW

We offer a vast range of windows & doors designs for the houseboats that are sure to add grace to your space.

We have an exotic range of high-quality aluminum home windows & doors that have been designed to enhance the aesthetics and to protect your home from the chaos of the world outside.

28. STAIRCASE

28.1 SPIRAL

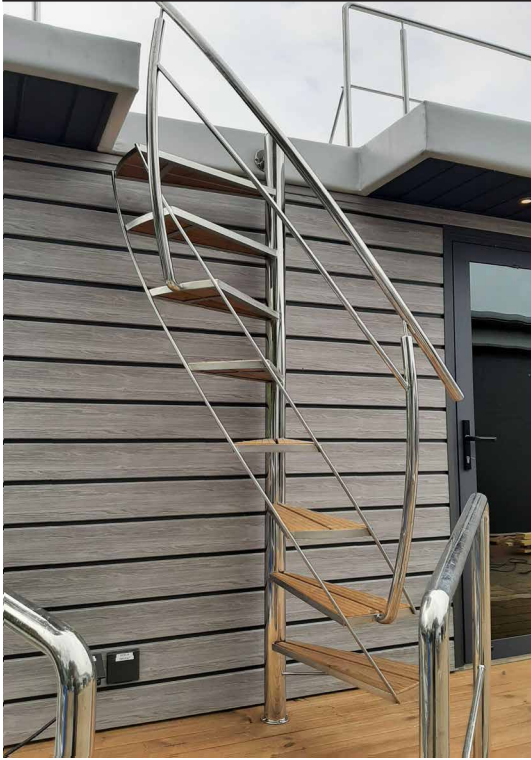

S1

FROM APART L TO XXL

28.2 STRAIGHT

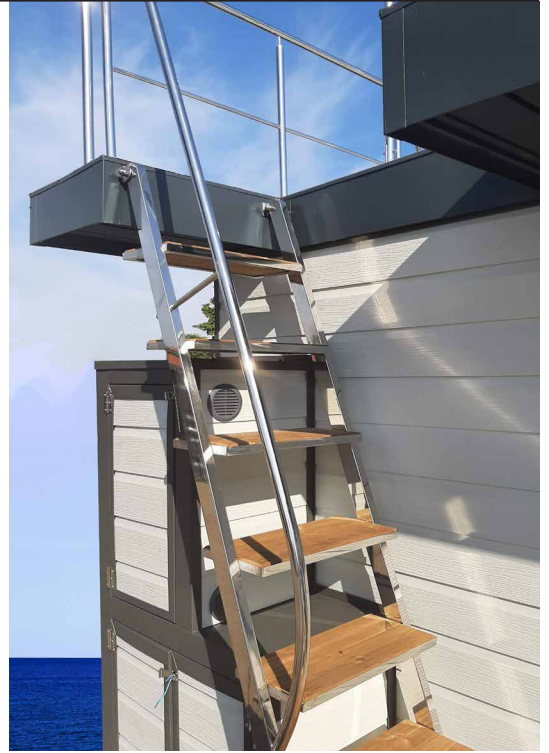

S2

FROM APART L TO XXL

28.3 LADDER



S3

FOR APART XS, S, M

28.4 FRONT STRAIGHT



S4

FROM APART L TO XXL

29. SIDE RAILINGS AND FLEXI TEAK



SIDE RAILINGS



FLEXI TEAK

30. WATER-WASTE SYSTEMS



24V FAECES PUMP



WASTE PUMP CONNECTION



CLEAN WATER FROM TANK



CLEANING WATER SYSTEM FROM SALT WATER



LAMARE SEWAGE TREATMENT PLANT



ETHERON 50 SEWAGE TREATMENT PLANT

31. BEDROOM

31.1 WARDROBE AND BED



PAX 50cm/60cm/37cm X 201cm



BED 130/140cm X 200cm or 160cm X 200cm

Bedroom furniture sets give you a shortcut to a complete, coordinated bedroom. They have all the essentials – a bed, a handy bedside table and storage for what you wear.

32. TV, RADIO AND SOCKET



RADIO PIONEER



RADIO TONSIL



SPEAKERS



RADIO FUSION



CAMERA



ANTENA GLOMEX



TV's 24" 32" 40"



TV-RADIO SOCKET



BEDLAMP



PRIORITY RELAY



CONNECTION 380V SOCKET AND CABLE PLUG

33. SAUNA AND GRADUATION TOWER



HOME GRADUATION TOWER



ELECTRIC SAUNA FOR 2 PERSON



Order the perfect wellness and relaxation space.

We have everything you need to create your own DIY sauna. All of this adds up to endless combinations to make sure that your sauna is uniquely designed for you.

34. CURTAINS



GREY



GRAY BLACKOUT

35. BLINDS

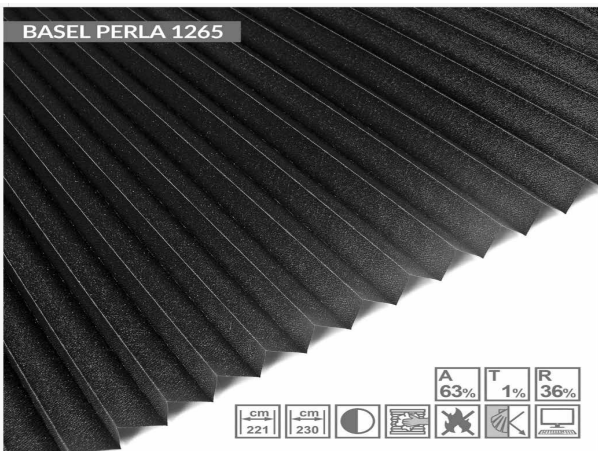

36. MODERN

36.1 EXTERNAL COLORS

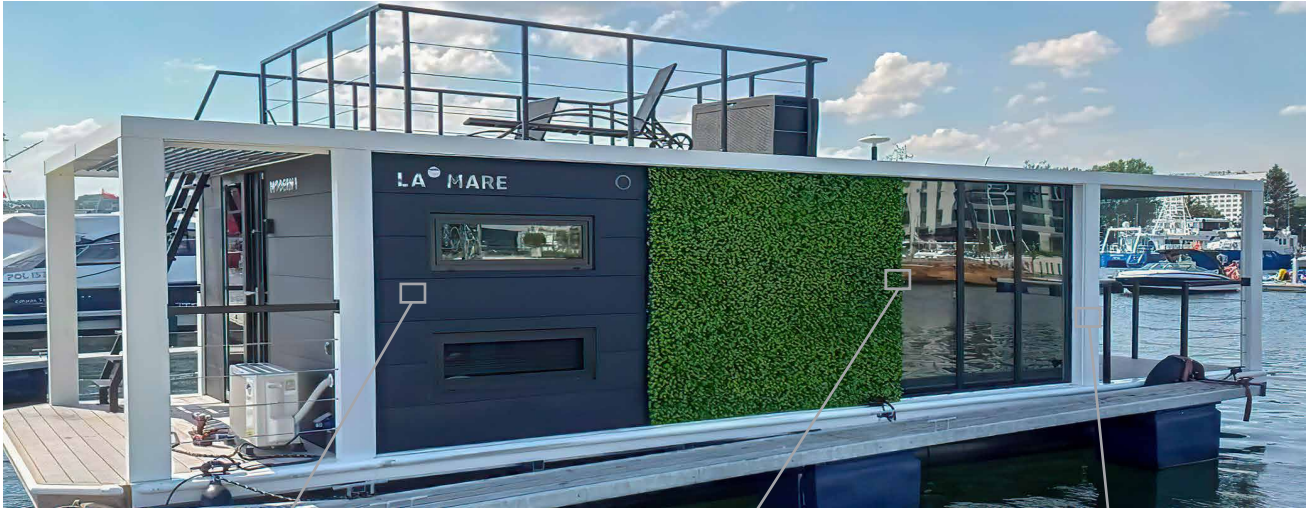

ANTHRACITE
BLACK
BROWN
WHITE



ANTHRACITE
BLACK
GREY
WHITE

36.2 KITCHEN, BATHROOM TAPS AND SHOWERS



KITCHEN -
LUGANO SLIM
BLACK



BATHROOM -
REA BLACK

BLACK SET



SHOWER ENCLOSURE BLACK



SHOWER BLACK



KITCHEN -
LUGANO SLIM
GOLD



BATHROOM -
REA GOLD

GOLD SET



SHOWER ENCLOSURE GOLD



SHOWER GOLD

36.3 BATHROOM CABINETS



BLACK CABINET

36.4 FABRIC WALLS



LIVING, SLEEPING ROOM
WALL v1

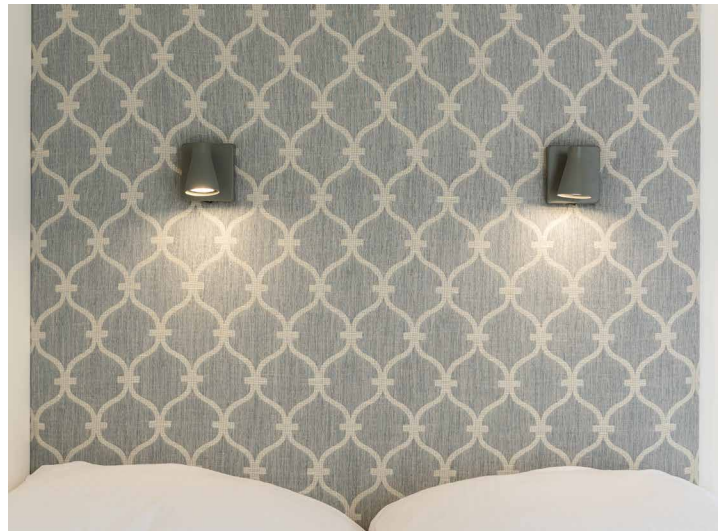

LIVING, SLEEPING ROOM
WALL v2

36.5 KITCHEN LAYOUT



STANDARD LAYOUT

37. LAYOUTS

APART M

APART M 1.1

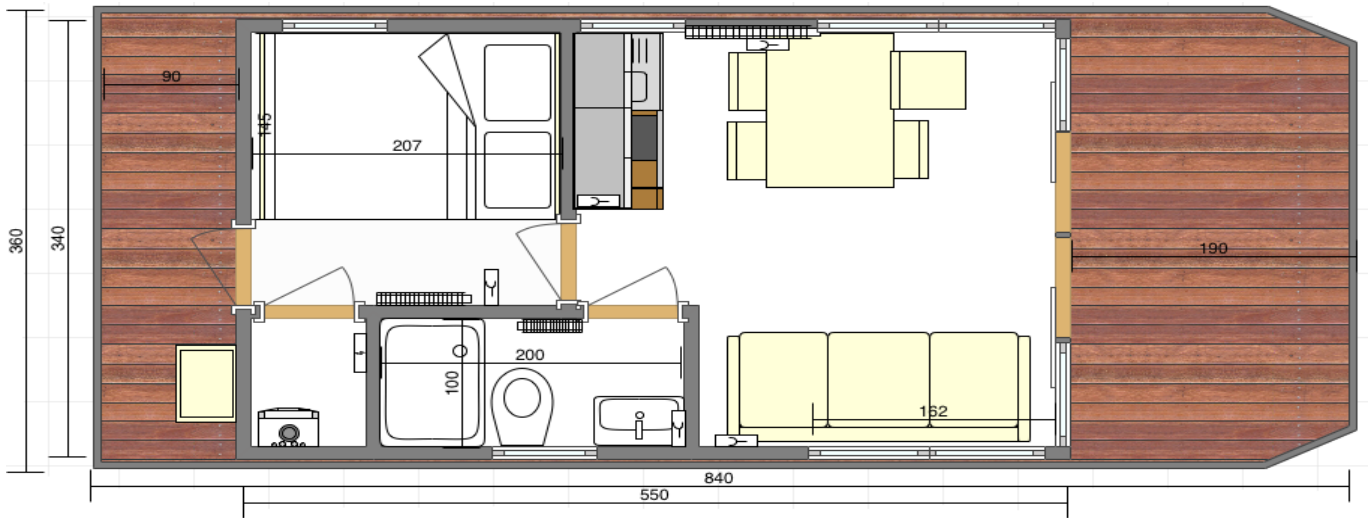

APART M 1.2

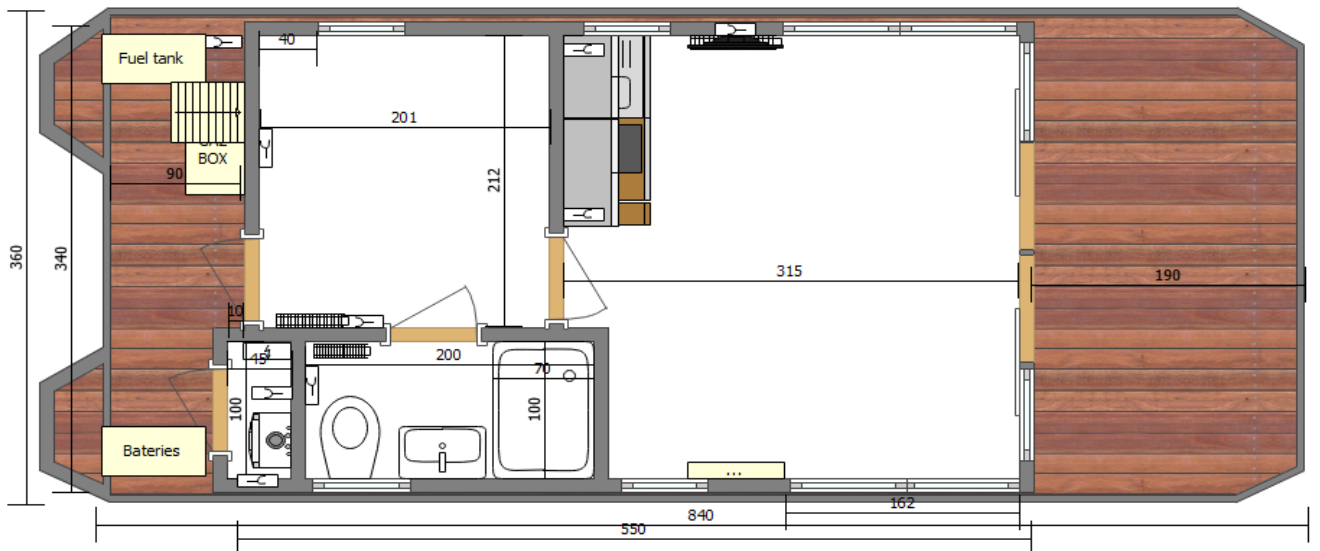

APART M 1.3

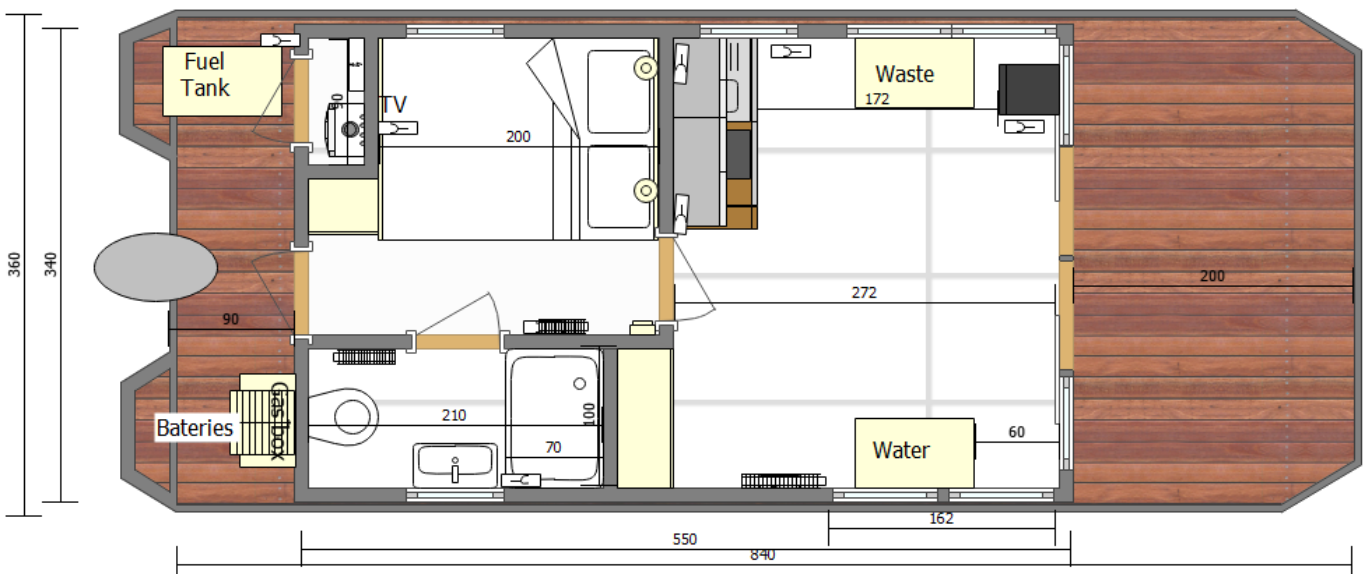

APART L

APART L 1.1

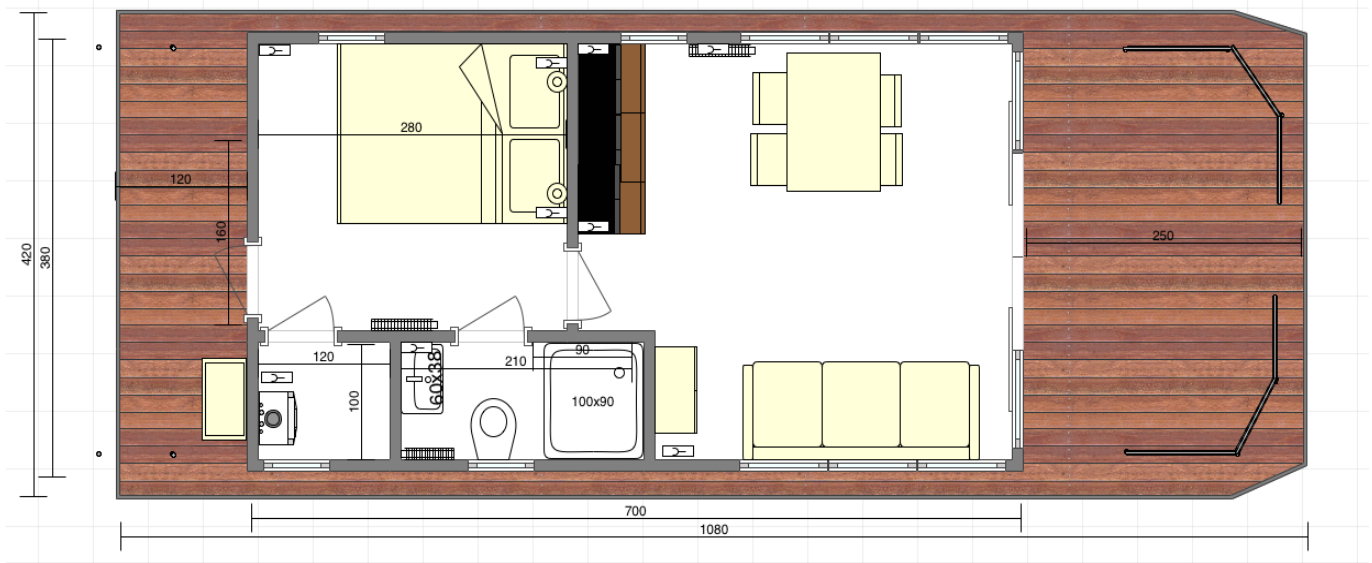

APART L 1.2

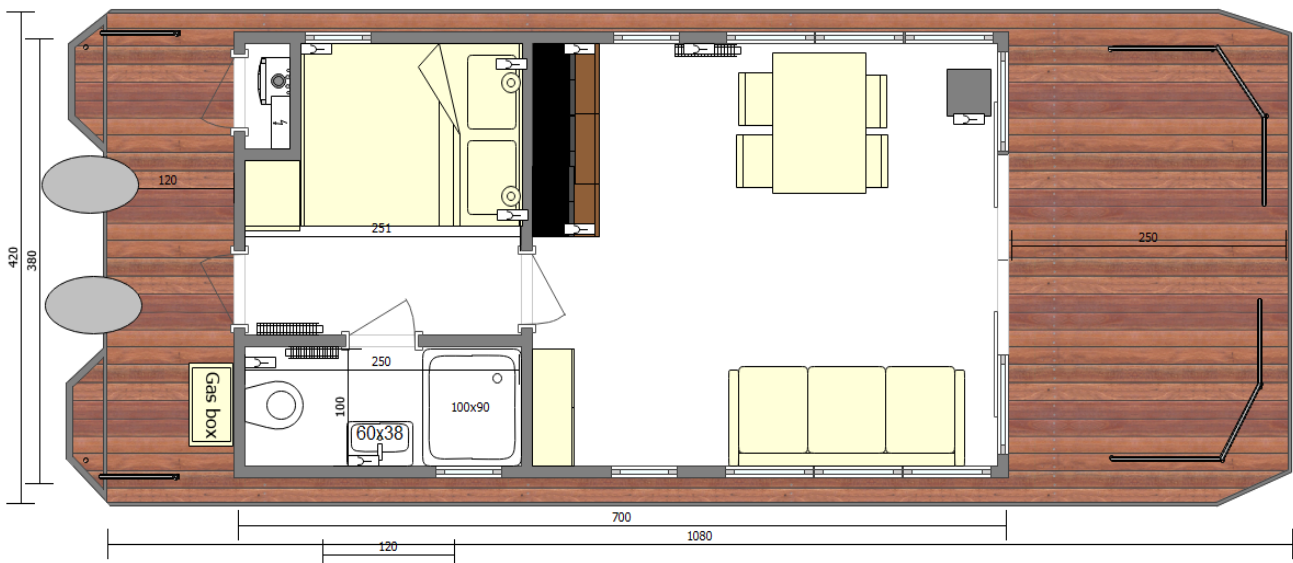

APART L 2.1

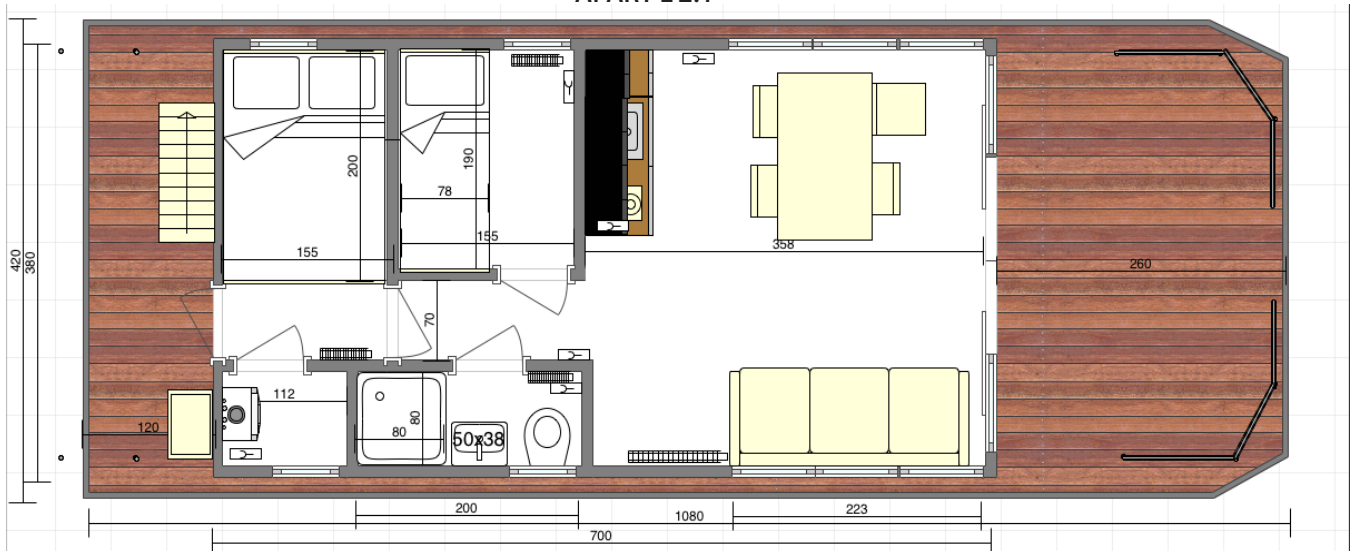

APART L LONG

APART L LONG 2.2

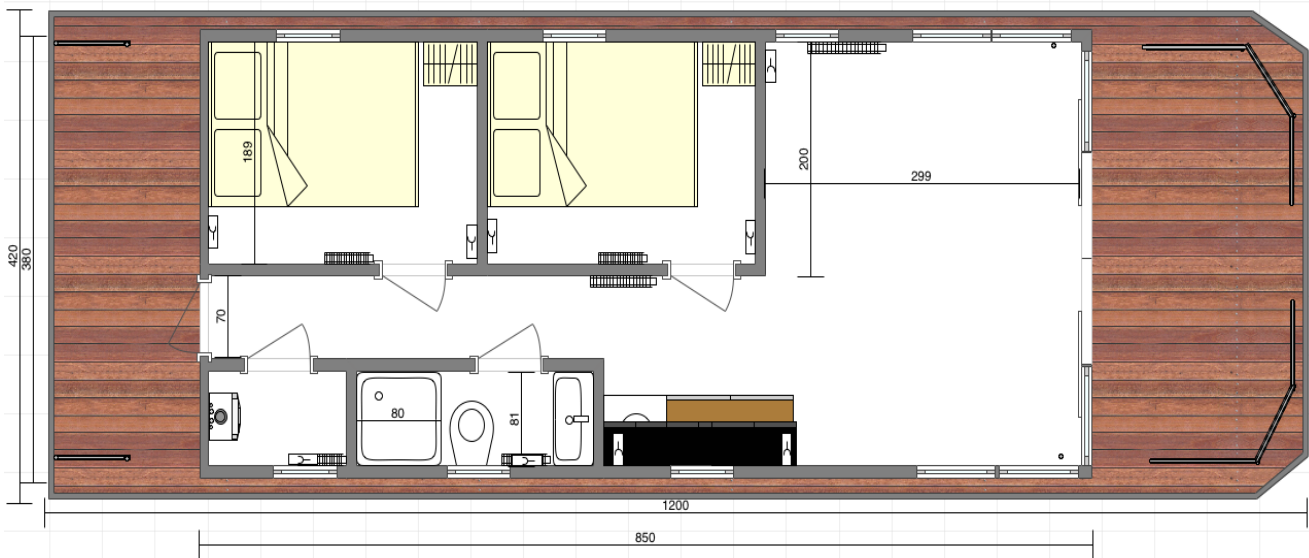

APART L LONG 2.4

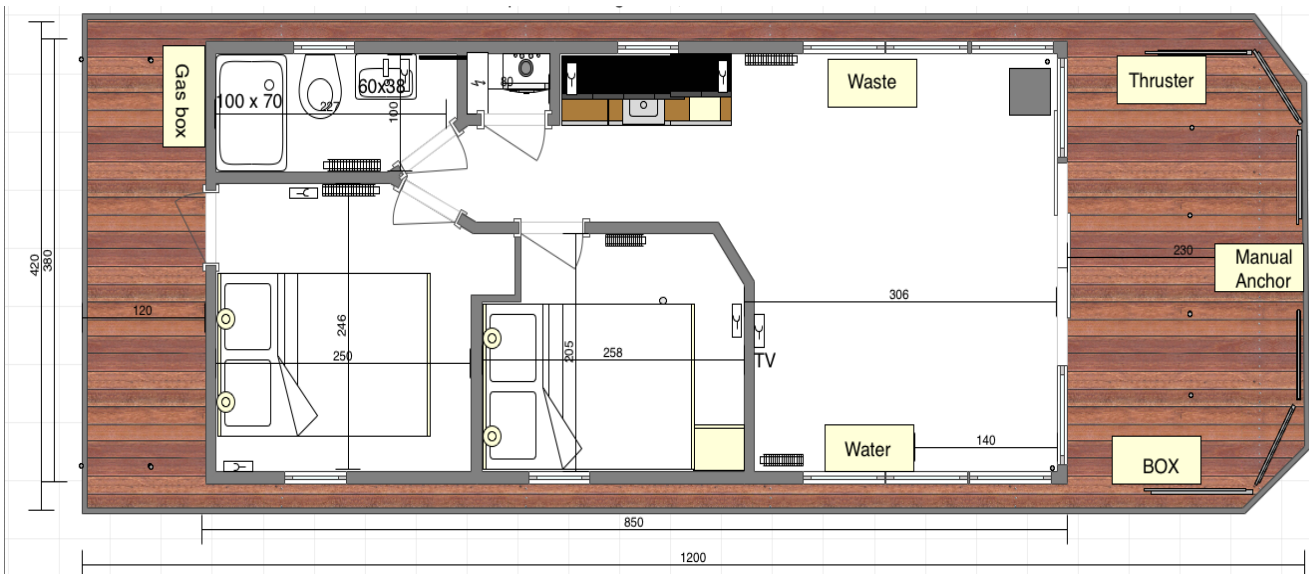

APART L LONG 2.2.1

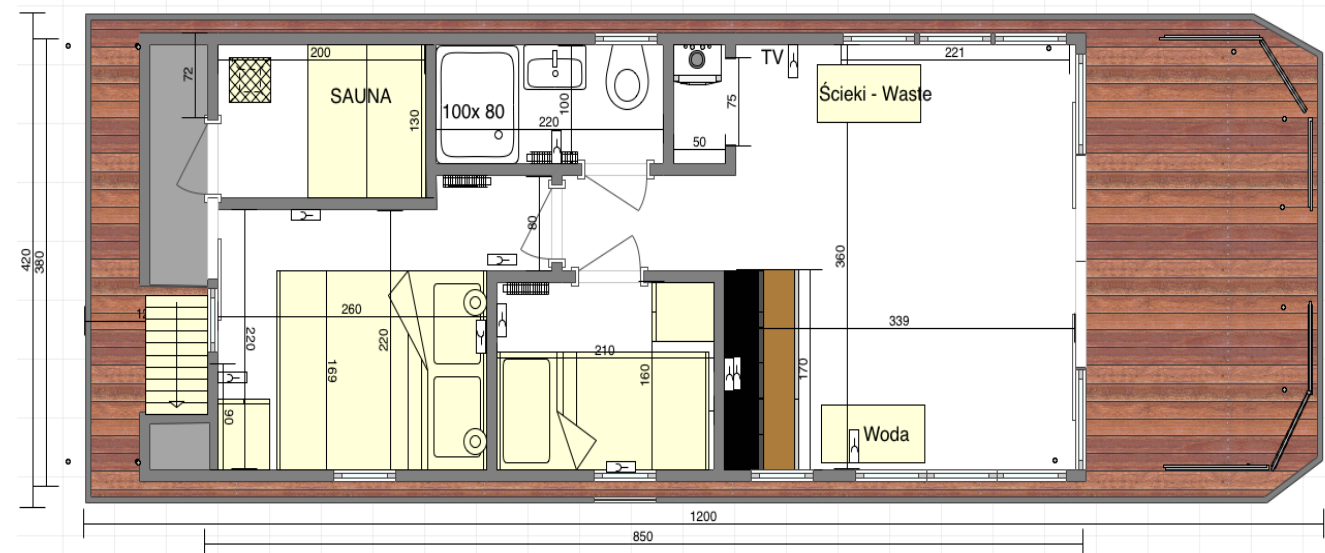

APART L LONG 2.7

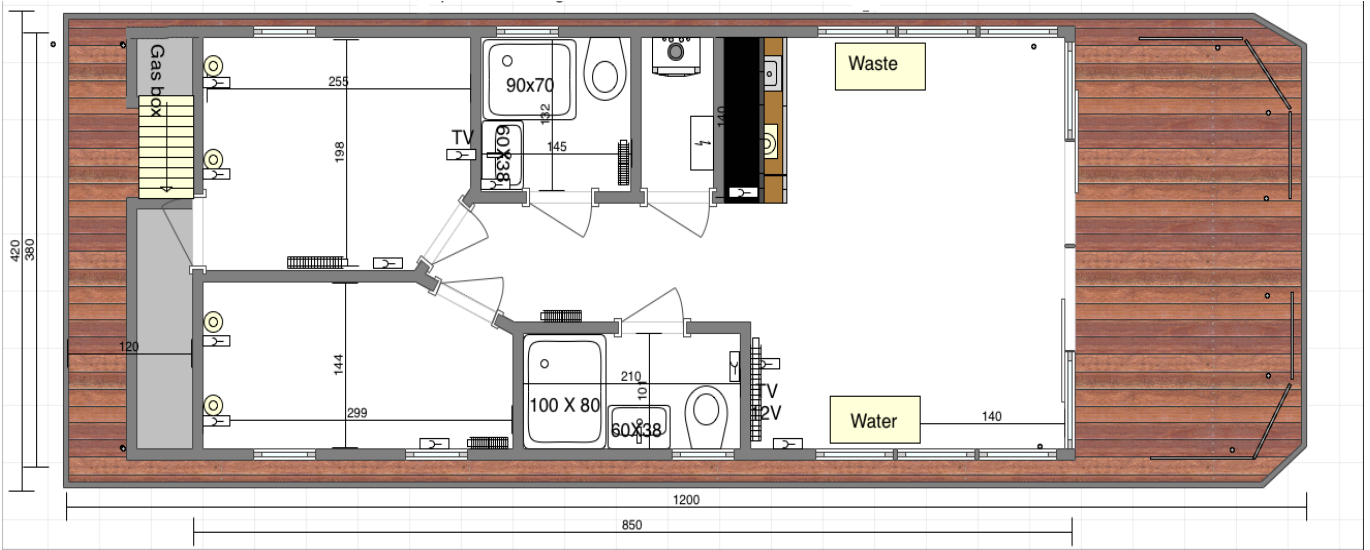

APART L LONG 2.8

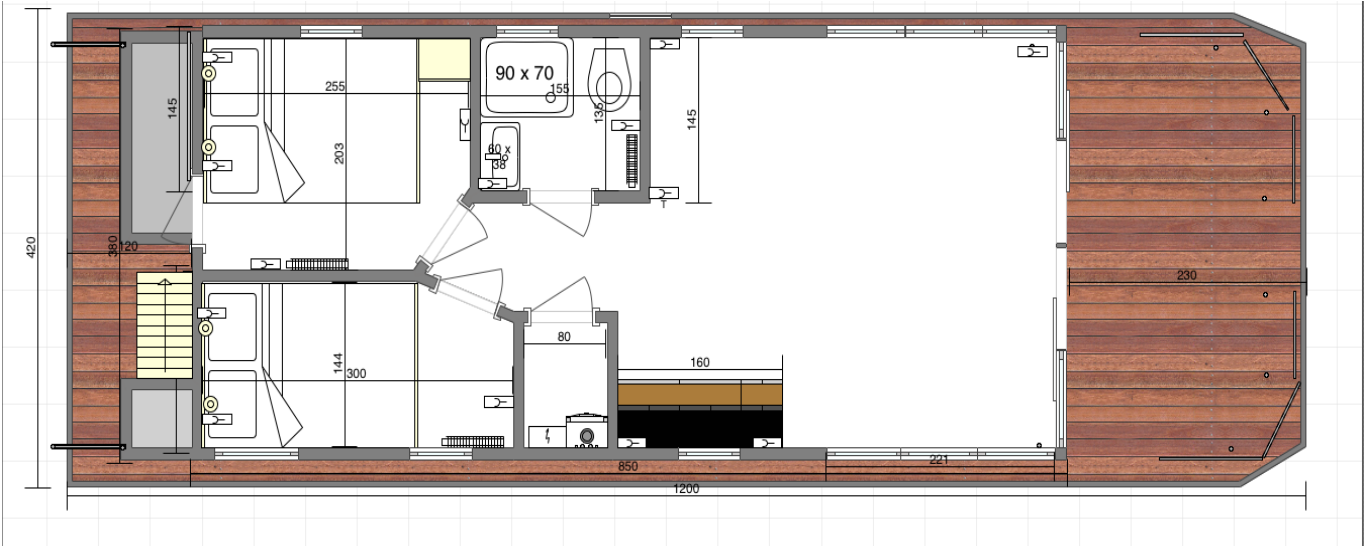

APART XL

APART XL 2.1

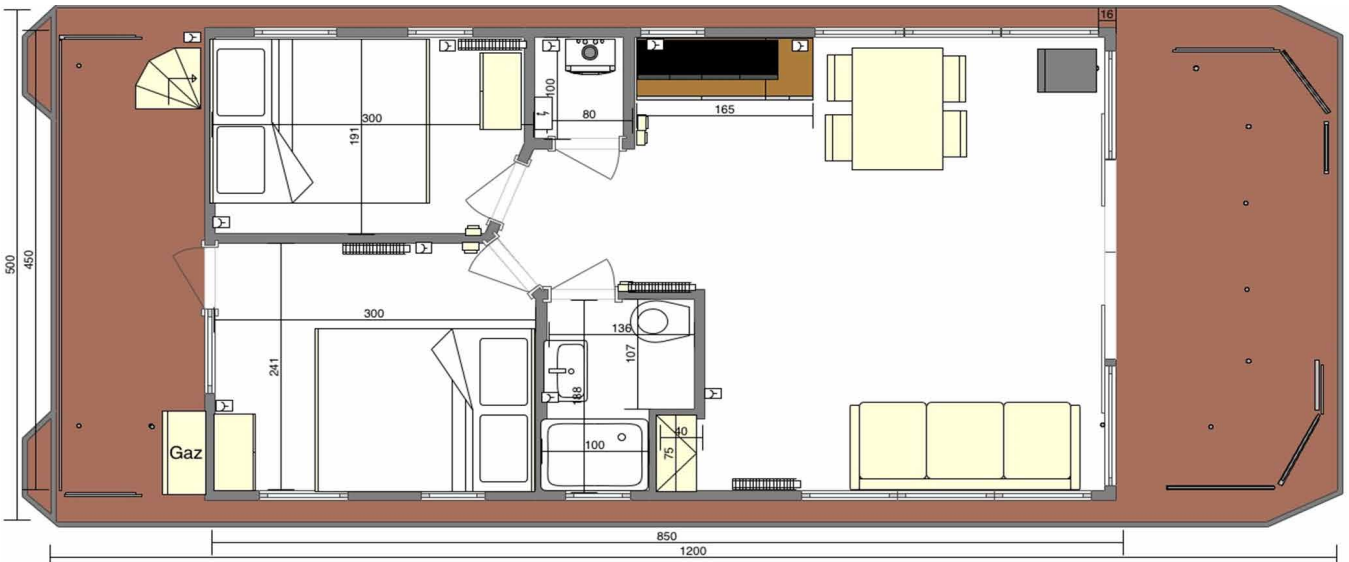

APART XL 2.2

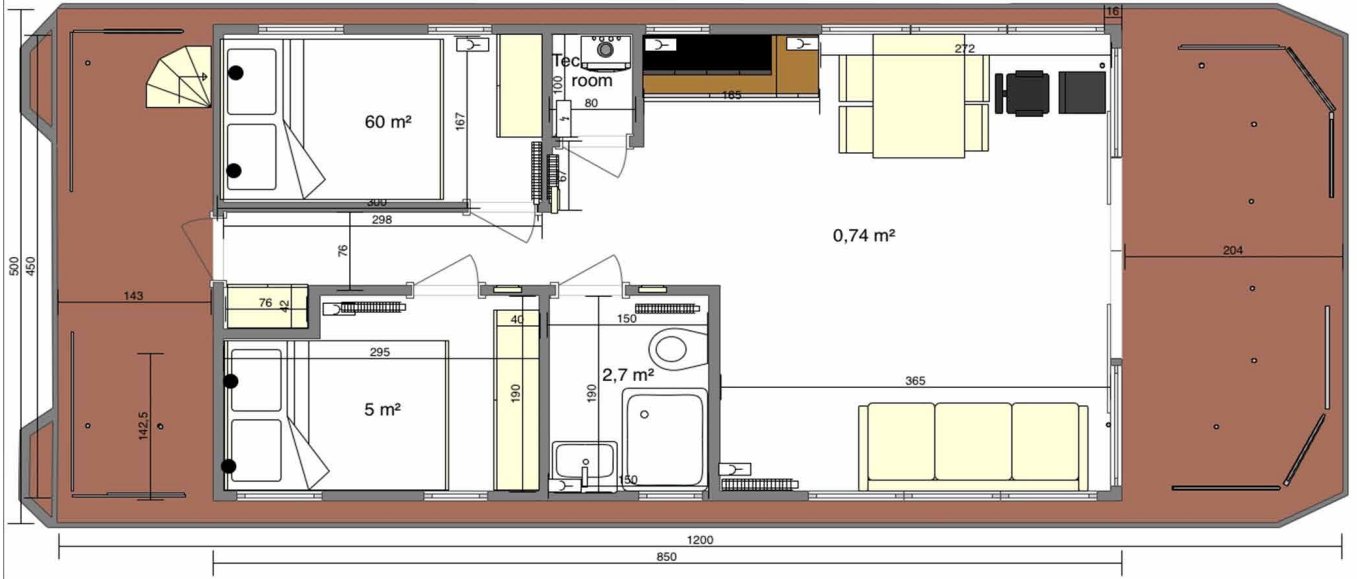

APART EL

APART EL 2.1

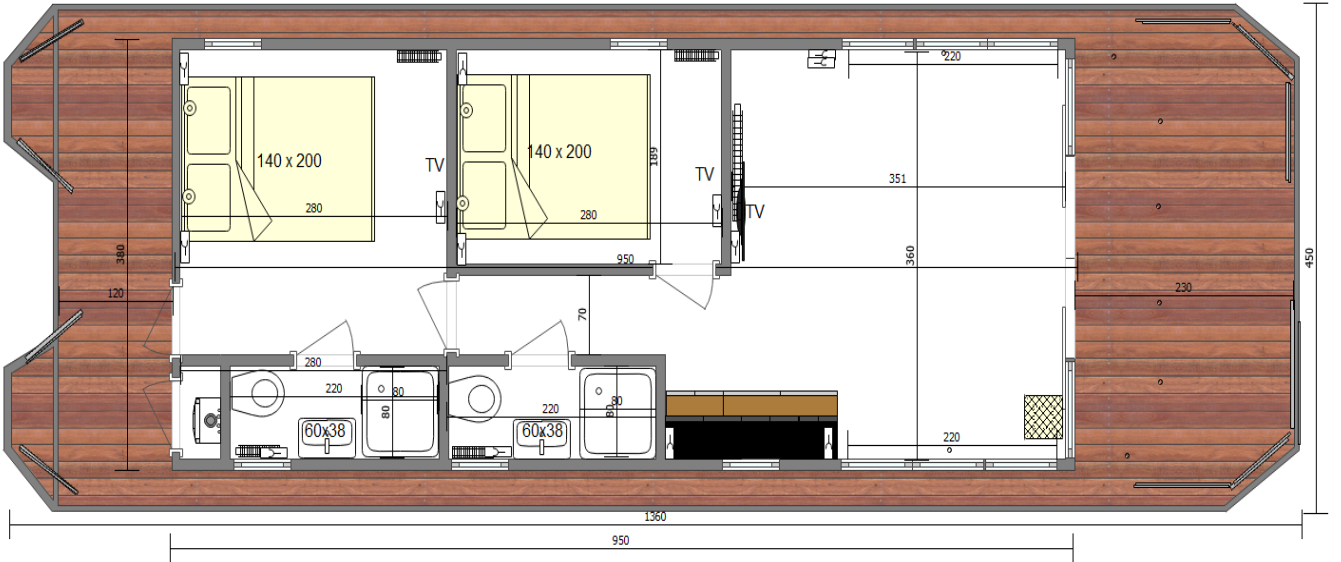

APART EL 2.2

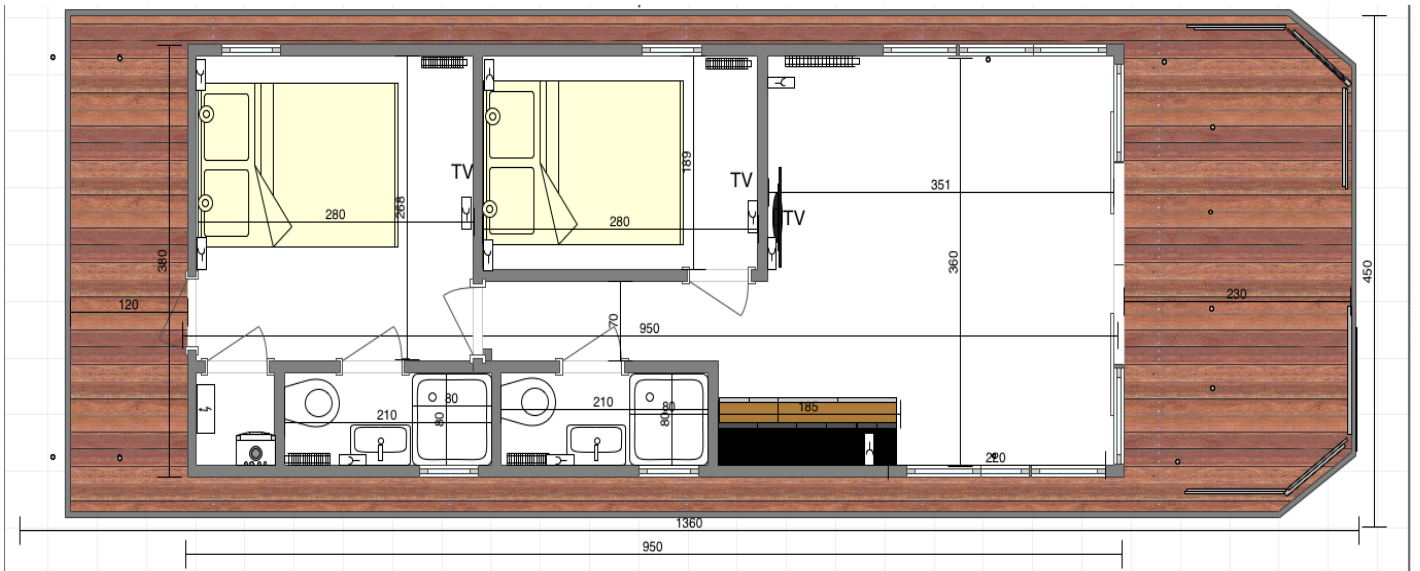

APART XXL

APART XXL 3.2

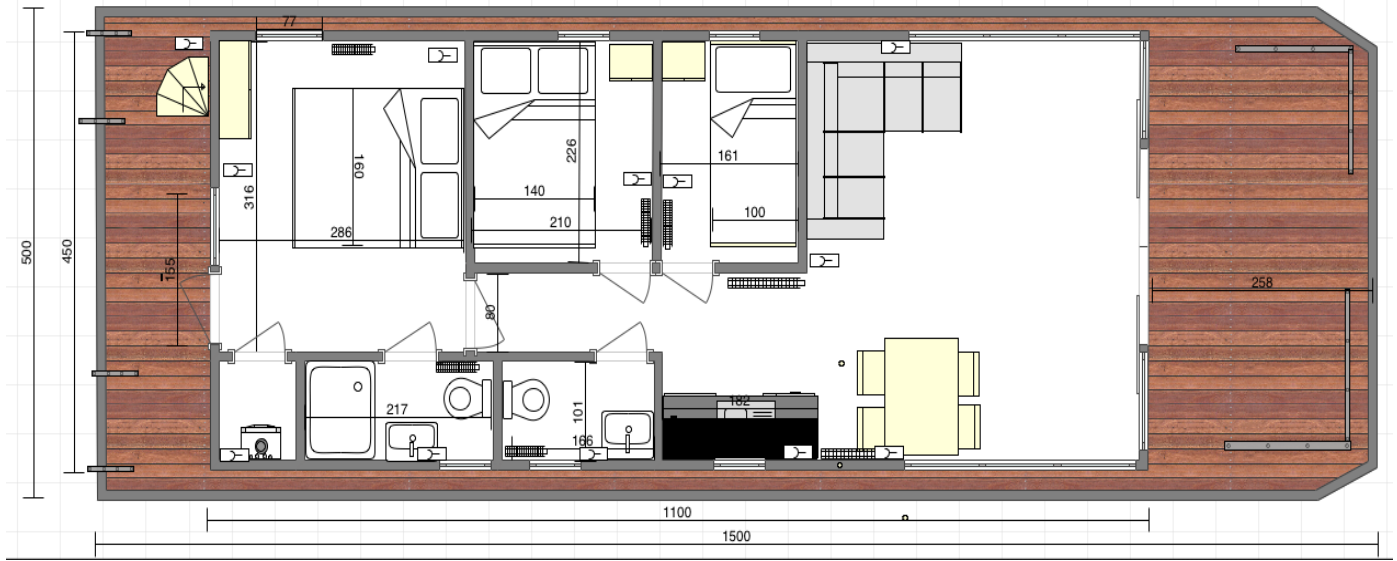

APART XXL 2.2

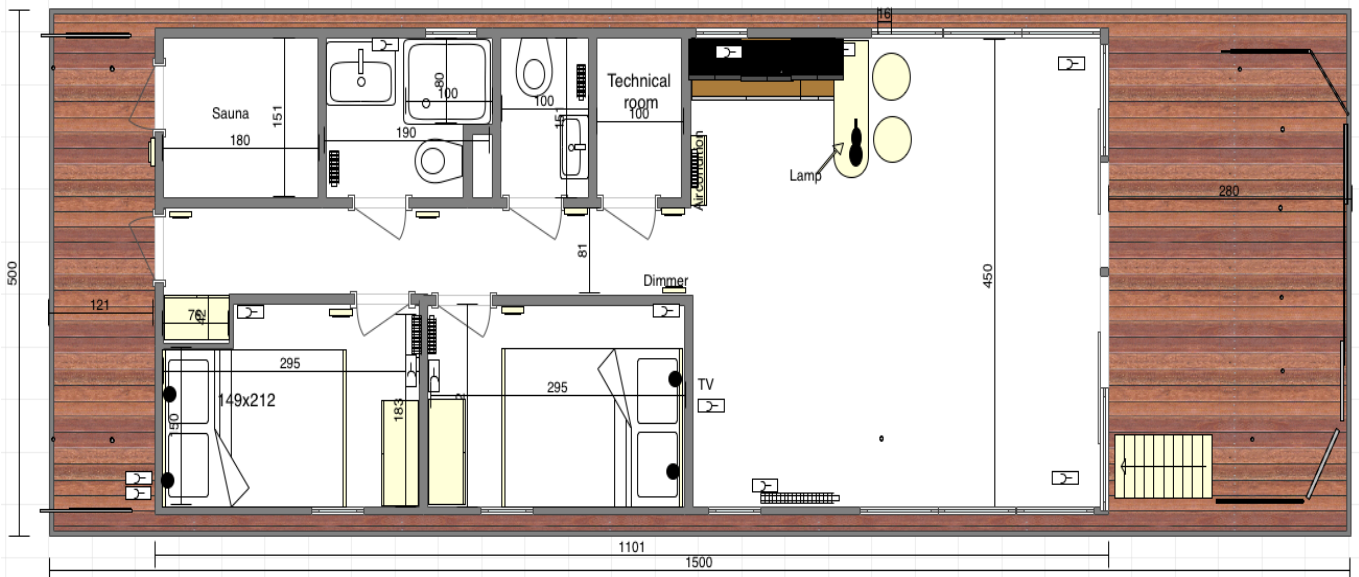

APART XXL 2.3

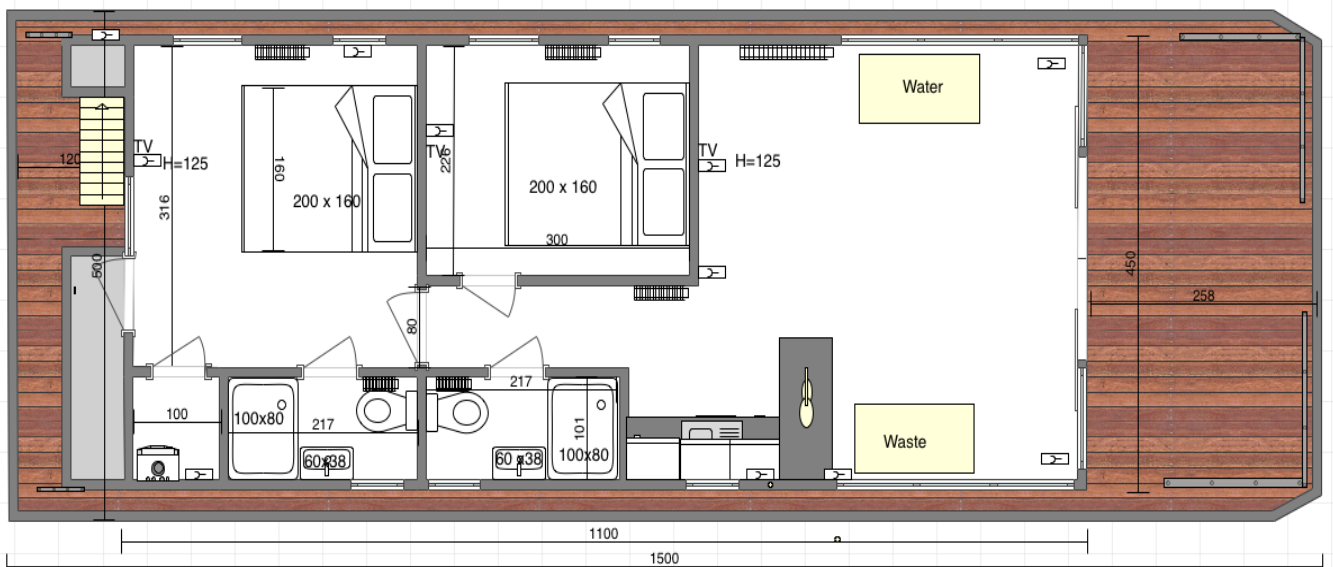

MODERN 2.1

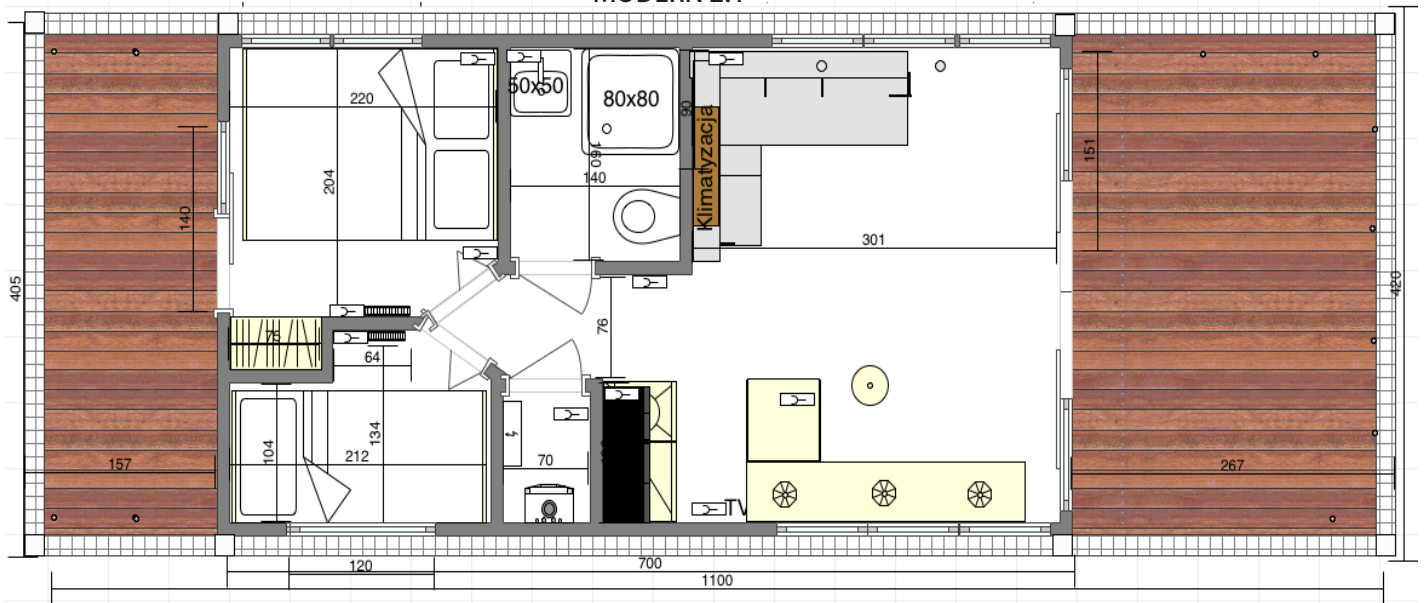

MODERN 2.2

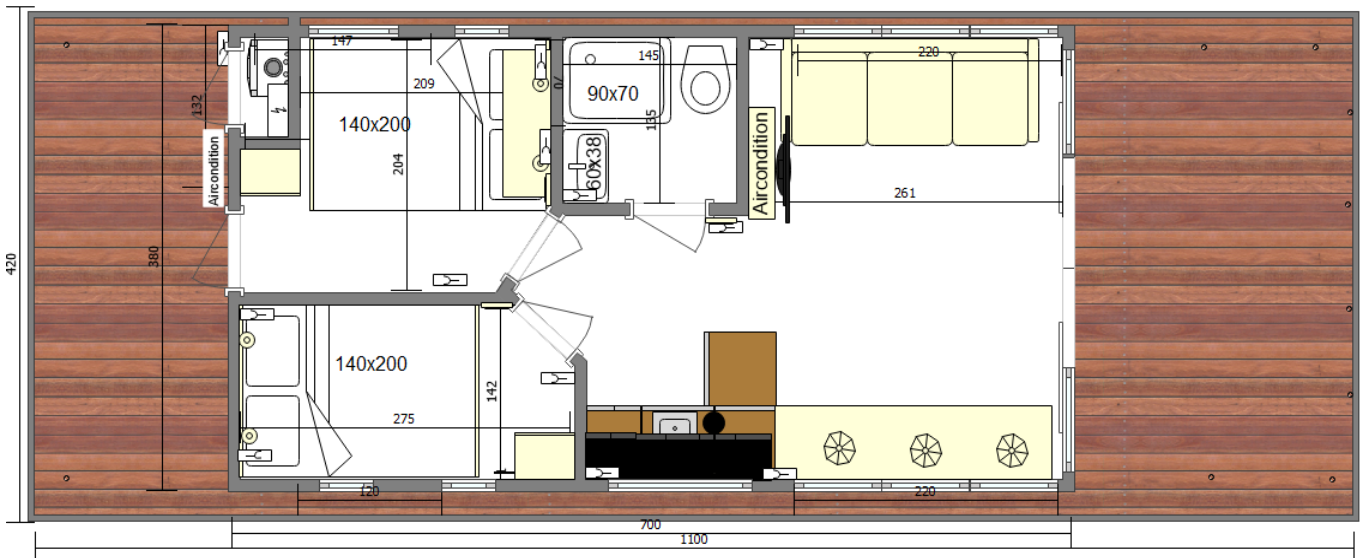



**70 Riverside Dr. Clinton,
CT 06413**



860-669-1705



www.waterlodge.com



info@waterlodge.com

Contact Us



MODELS